

Schnittmuster Dragoran / Pattern of Dragonite

+ Wer Dragoran näht und online postet erwähnt mich bitte dazu oder verlinkt meine Seite!

Dies ist ein kostenloses Schnittmuster. Ihr dürft diesen Schnitt weder als Euren ausgeben, noch dürft Ihr ihn verkaufen. /

When you sew dragonite with my pattern and post it online, please mention me or link my page!!

This pattern is for free, you are not allowed to say it's yours and you are not allowed to sell this pattern!

+ Nahtzugabe inkludiert / including seam allowance

Plüschrichtung /
fur direction

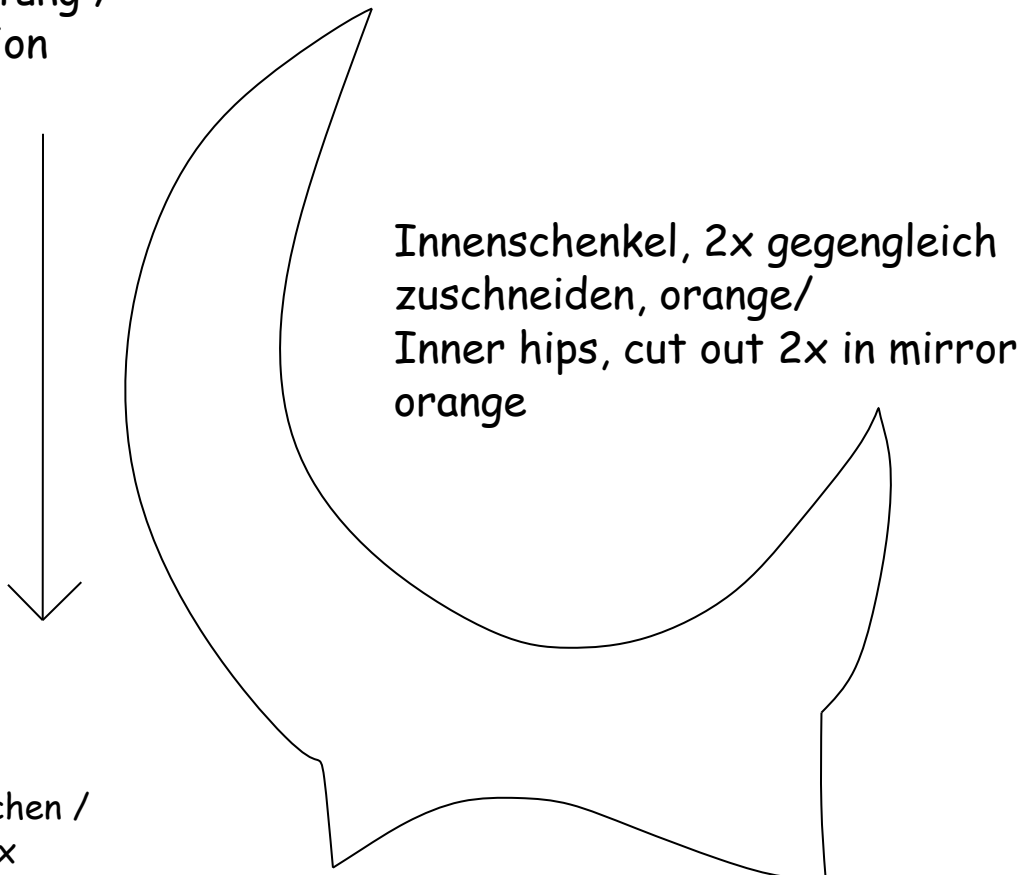

Kontrollkästchen /
checkbox

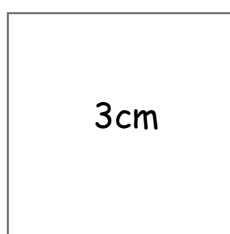

Richtung dehnbar /
direction of stretch

A horizontal double-headed arrow pointing left and right, indicating the stretch direction.

Bauch Wollweiss/
Belly Ivory 1x

www.facebook.com/sayky97

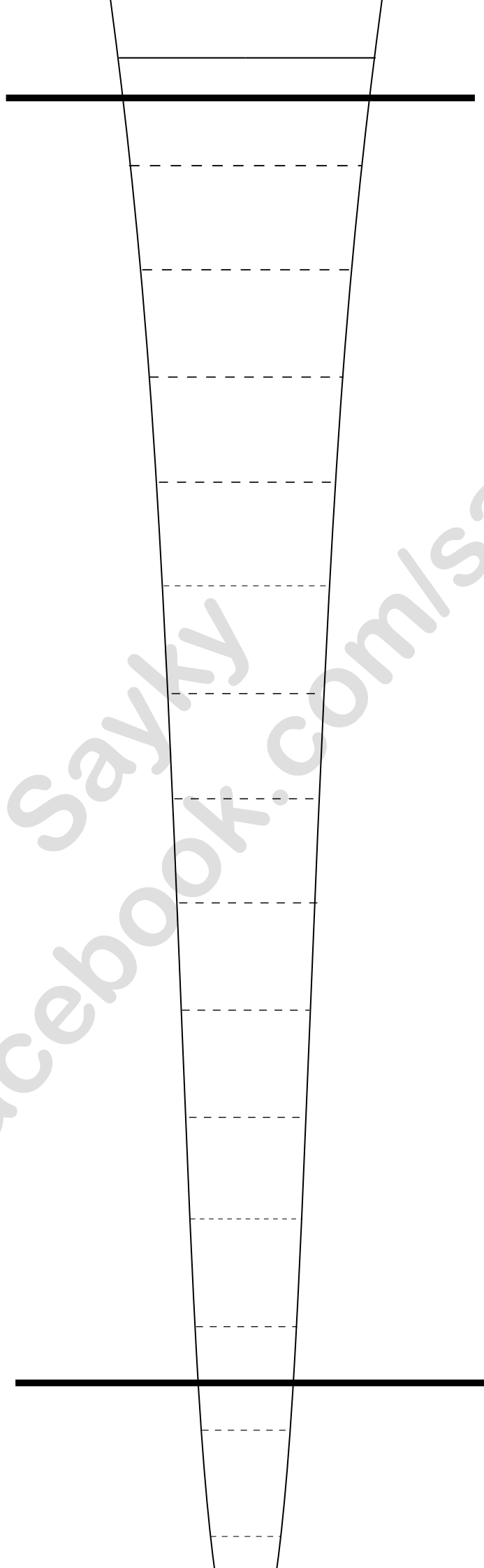

www.facebook.com/sayky97



NAHTZUGABE GEBEN!!/GIVE SEAM ALLOWANCE

Körper orange, 2x gegengleich zuschneiden/
Body orange, cut out 2x in mirror

Körper oben rechts, orange 1x/
Body piece right side, orange 1x

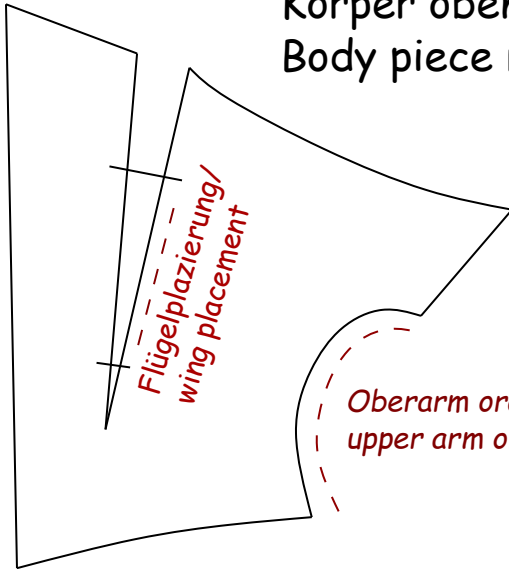

Körper oben links, orange 1x/
Body piece left side, orange 1x

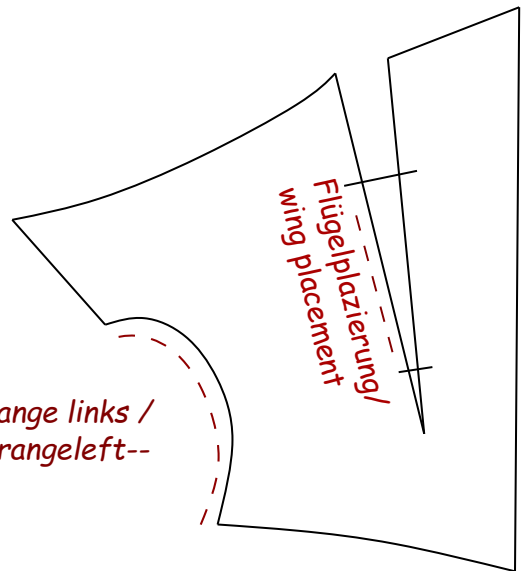

Oberarm orange links /
upper arm orange left--

Fühler, NAHTZUGABE GEBEN, Wollweiß 4x, /
Antennas, GIVE SEAM ALLOWANCE, IVORY 4x

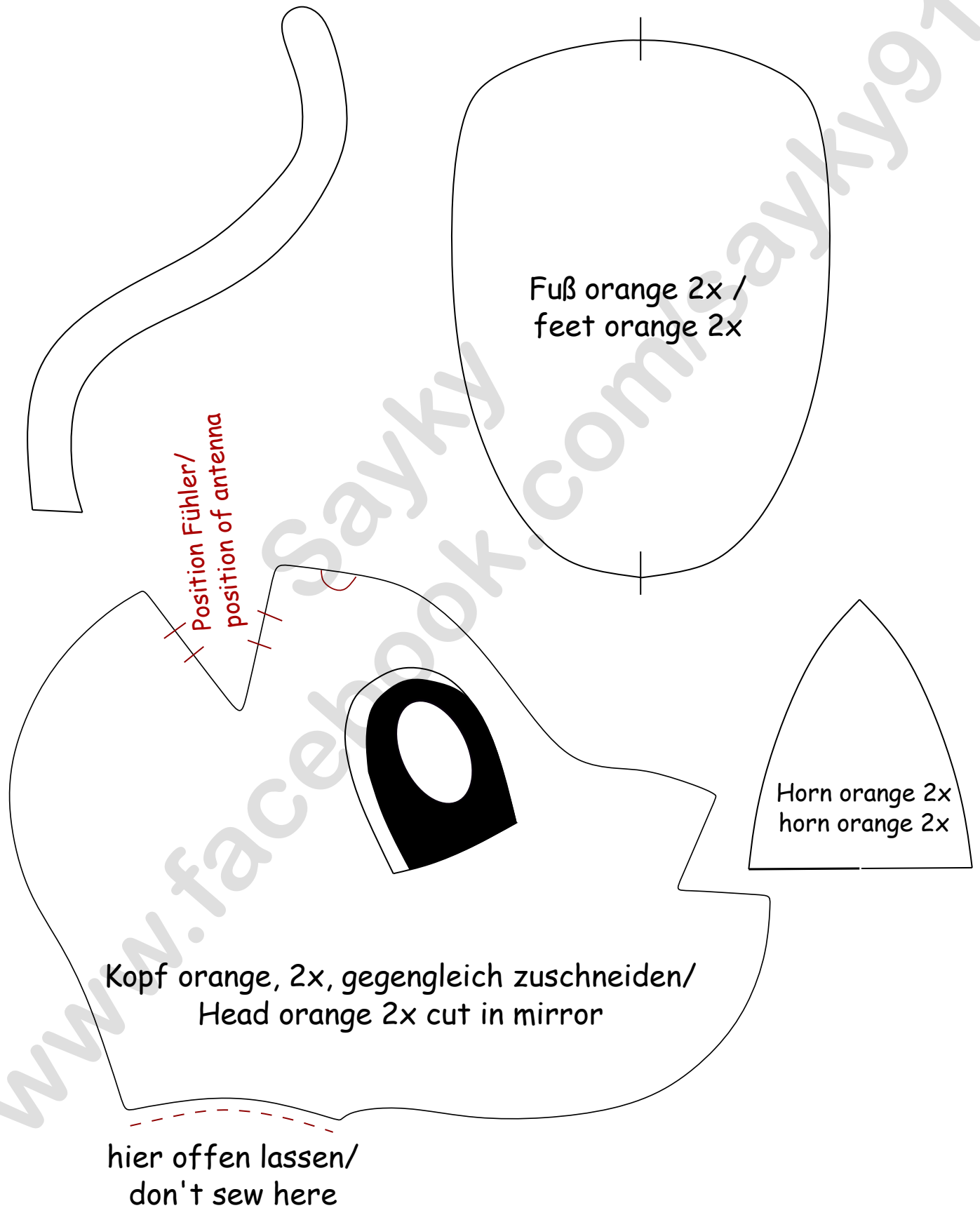

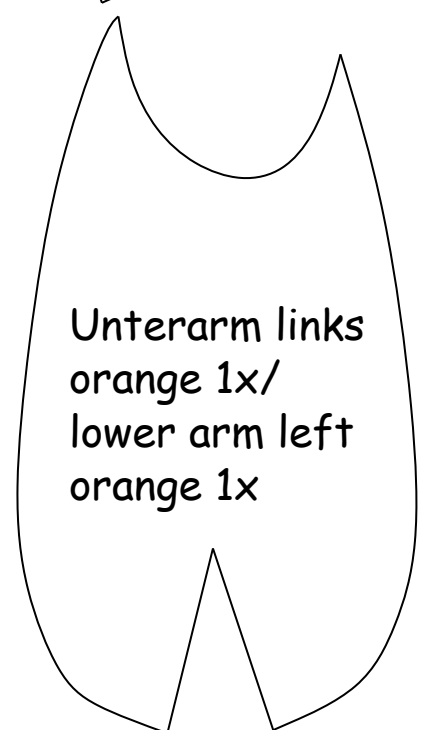
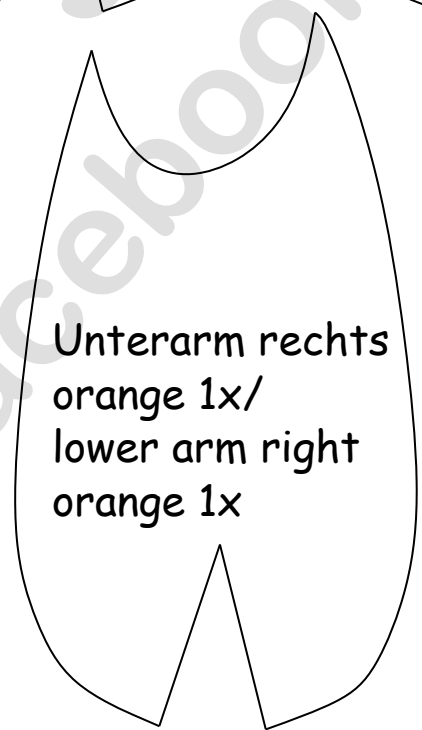
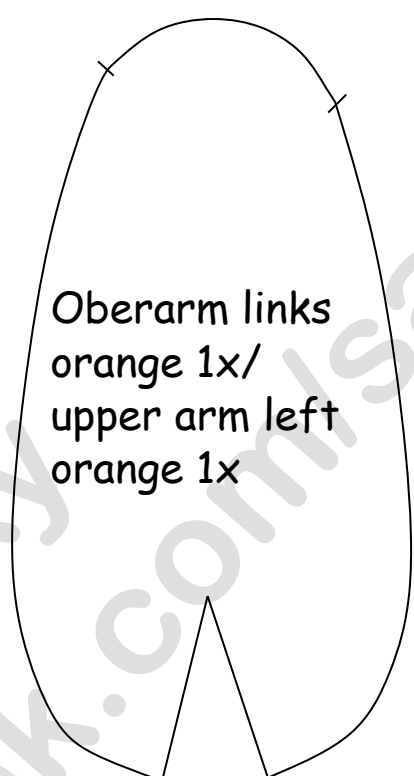

www.facebook.com/sayky97

Kopf orange 1x/
Head orange 1x

Position Horn /
position of horn

Nasenlöcher/
noseholes

Fuß orange 2x /
feet orange 2x

Flügel, petrol 2x
gegengleich ausschneiden /
wing, petrol 2x
cut out in mirror

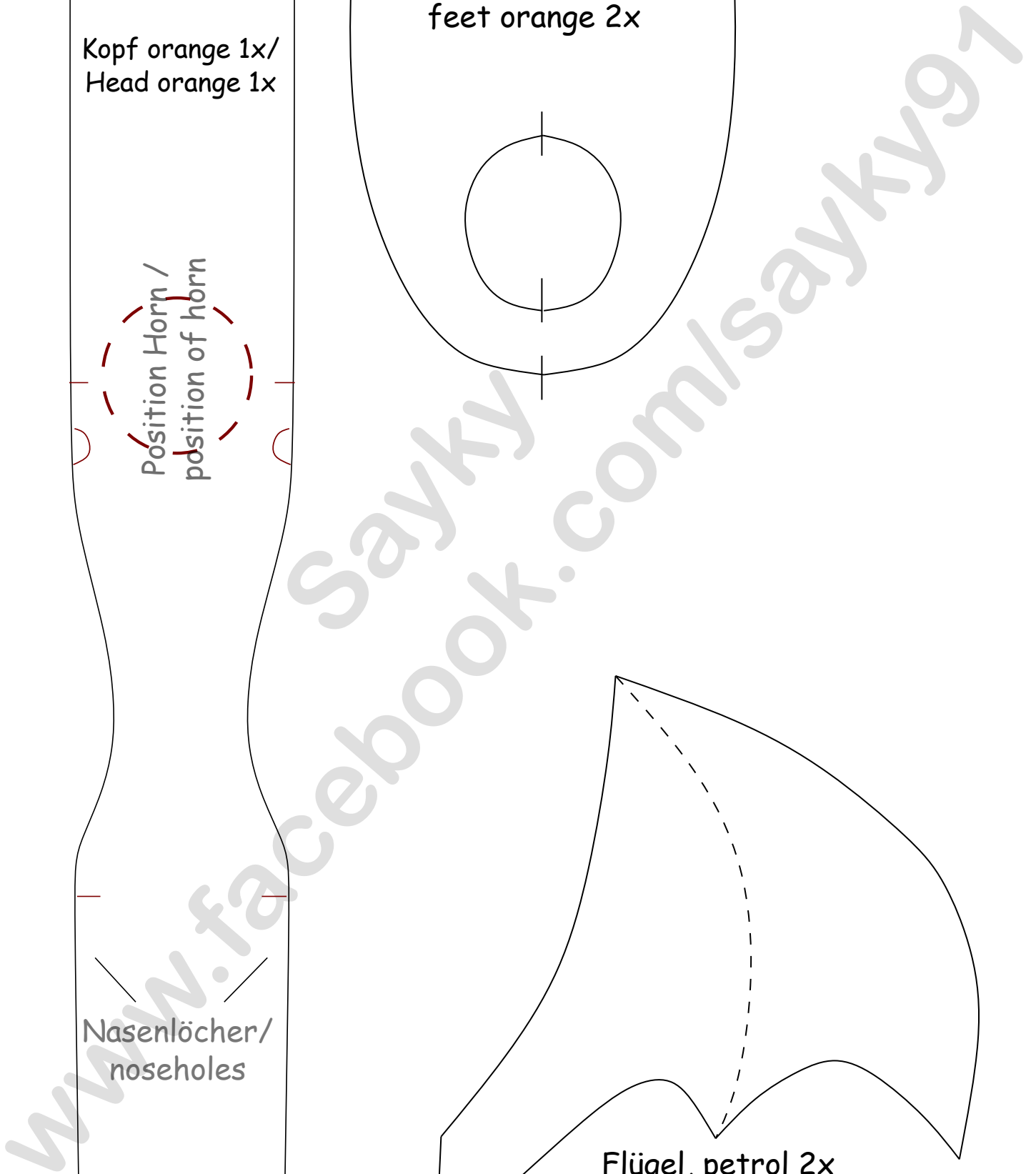

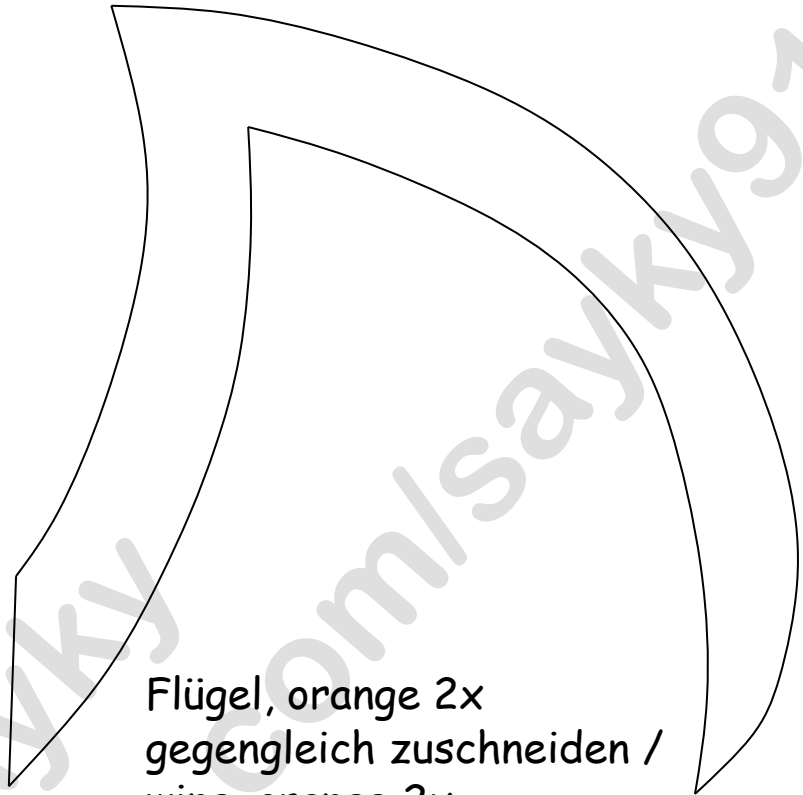
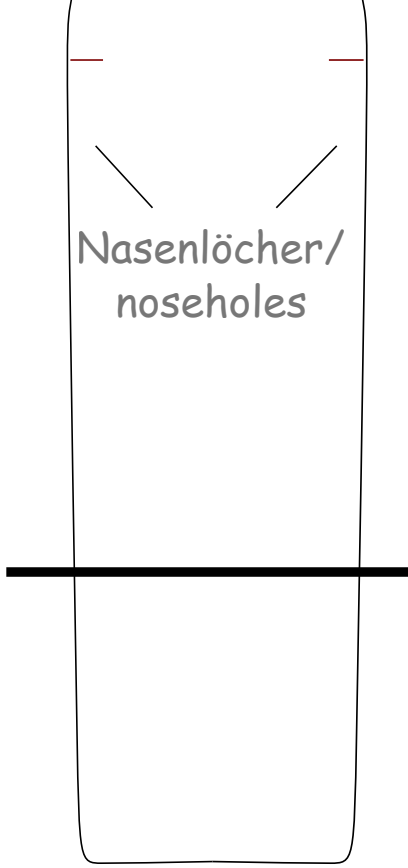

Flügel, orange 2x
gegengleich zuschneiden /
wing, orange 2x
cut out in mirror